



ELECTRAULIC™ ACTUATORS & DRIVES

BULLETIN X2R-1

FEATURES

- 100% modulating duty cycle
- Deadband: adjustable from 5% to 0.05%
- Input signal: 4-20 mA analog or pulses
- Repeatability: <0.1%
- Resolution: adjustable to <0.1%
- Linearity: correctable to <0.05%
- Optional spring failure upon power loss
- Self-contained, single unit design
- Microprocessor controlled for reliability and flexibility
- Discrete operation: motor only operates when motion is required

Xpac Series

X2R-Rotary Actuators

REXA Xpac actuators feature a self-contained **Electraulic™** power module utilizing the patented Flow Match System. This technology allows precise positioning independent of load variation and locks the cylinder in place when no movement is required. Hydraulic flow is generated by an internal positive displacement gear pump driven by a continuous duty motor without limitations on start, stop, or reverse cycles.

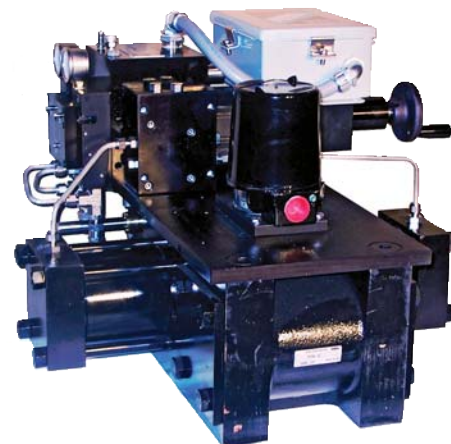

Power modules are available in B, C, ½D and D sizes. The difference between the sizes is the maximum flow rate of the hydraulic oil and thus the maximum stroking speed for an actuator. Size C has three times the capacity of a B; the ½D has six times the capacity of a B; and the D size has twelve times the capacity of a B. Greater speeds can be obtained by using a manifold containing multiple modules or REXA's unique Booster Pump system. This approach to product configuration offers a high degree of commonality and reduces spare parts inventory. The required rotation rate for an application determines the size and quantity of the modules. Regardless of the selected power module, the rated torque remains unchanged for any given cylinder size.

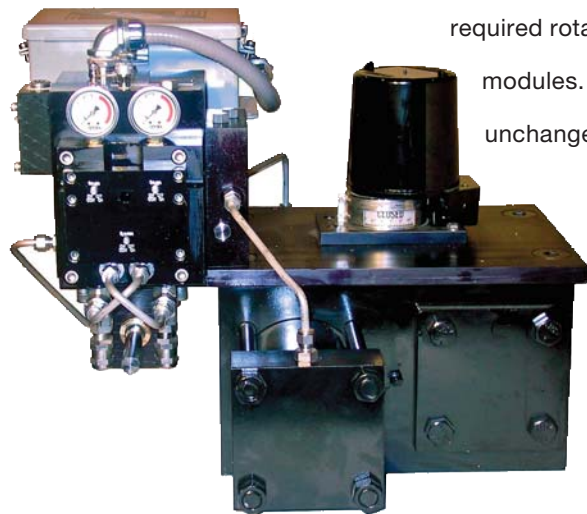

The R series actuator is designed by combining a quarter turn rack and pinion cylinder and the power modules. Torques from 600 lb·in to 400 000 lb·in are standard. A female keyed shaft connection and four bolt mounting pattern make for a straight forward adaptation to ball valves, butterfly valves, louvers or any device requiring rotation up to 90 degrees (optional to 280 degrees).

Electraulic™ Actuation

The word Electraulic™ was coined by REXA to describe our revolutionary technology which combines the simplicity of electric operation, the power of hydraulics, the reliability of solid state electronics and the flexibility of user configured control. A hydraulic system has long been recognized as providing superior performance in the operation of final control elements. Unfortunately, advantages such as quick response, precision and high stiffness were often outweighed by frequent maintenance, nonstandard construction and high cost. By utilizing Electraulic technology, REXA is able to bring to general process control the advantages of hydraulic operation without the conventional drawbacks. Self-contained actuator mounted hydraulics, low maintenance, low power consumption and rugged components are inherent in REXA's proven design.

The foundation of Electraulic technology is the Flow Match System, a patented breakthrough in hydraulic circuitry. Motor oil, driven by a continuous duty motor and gear pump, is transferred through the Flow Match Valves (FMV) from one side of a double acting cylinder to the other. Variations in magnitude and direction of the load have no effect upon control. When position is reached the motor shuts off and the FMVs lock the actuator in place. For the complete story, request the publication *Theory of Operation*.

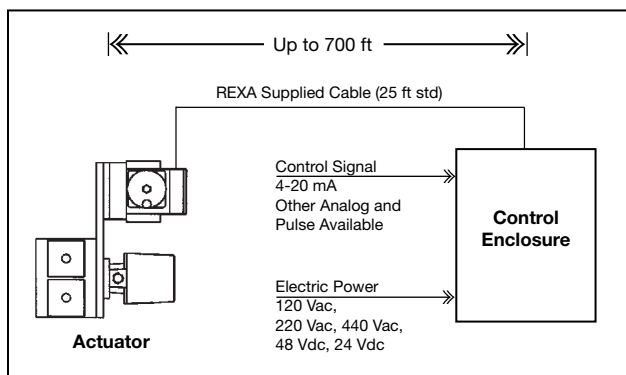

Control Processor

The Xpac is operated by a dedicated microprocessor, the position Control Processor (CPU). Contained within the control enclosure, the CPU has three modes of operation: *Automatic*, *Setup* and *Local*. For modulating operation, the CPU is in the *Automatic* Mode and functions much like a conventional positioner. The control signal and actuator's position (indicated on the enclosure display) are continually compared to each other. If the difference between these values is greater than the selected deadband, then the motor is rotated in the required direction until the new position is reached. Response to a change in control signal is immediate.

The CPU is calibrated in the *Setup* mode by a simple routine which provides the user complete control over actuator operating parameters. Speed, stroke, deadband, acceleration, control signal, and gain can be configured into the CPU by using a keypad and display. This menu-driven *Setup* eliminates the time consuming and often difficult procedures associated with limit and/or torque switches and potentiometers. Programmed parameters are retained in a permanent memory. For unusual or difficult applications, more sophisticated control capabilities such as flow characterization and water hammer suppression (two speed) are available. To protect saved setup parameters from unwarranted change, access to the *Setup* mode can be restricted by a pass code.

Local mode allows stroking of the Xpac from the keypad on the CPU. The display will indicate actuator position. The current control signal and last encountered error can also be shown. ■

X2R Specifications

		Xpac Rotary Actuator				CE European Compliance (OPT)	
Outputs		600 lbf-in–400 000 lbf-in (68 N·m–45 194 N·m) For higher outputs, contact the factory.					
Control Signal		Analog: 4–20 mA (STD) Pulse: 24–120 Vac or Vdc					
Deadband		Adjustable from 5% to 0.05% ‡					
Failure Mode		Fail-in-place (STD); Spring or Accumulator for fail open/closed (OPT)					
Materials of Construction		Anodized aluminum (Electraulic module), anodized aluminum and steel (rack and pinion cylinder)					
Environmental Rating		NEMA 4 (STD); IP65; NEMA 4X (OPT) Electronics					
Hazardous Location Rating (OPT)		Explosion Protection: CSA approved Class I, Division 2 (Refer to TM6 for details.)					
Feedback		Thin film potentiometer (10x10 ⁶ cycles)					
Temperature Range¹	Actuator Construction	Standard				High Temp.	
	Type R Rotary Cylinder	+10 °F to +200 °F	-10 °F to +200 °F	-76 °F to +200 °F	-5 °F to +250 °F		
		(-12 °C to +93 °C)	(-23 °C to +93 °C)	(-60 °C to +93 °C)	(-20 °C to +121 °C)		
Installation Requirements	None	1 inch of thermal insulation†	Heat tracing & 1 inch thermal insulation†		Optional High Temp. Construction		
Electronics Temperature Range²		Separate Control Enclosure with CPU, motor driver, power supply, transient protection and termination.					
		-40 °F to +140 °F (-40 °C to +60 °C)		-40 °F to +120 °F (-40 °C to +50 °C)			
Motor Type		Stepper			Servo		
Motor Designation		B	C	½D	D	D, P9	D,P40
Power Requirements	12 Vdc	OPT	CF	CF	—	—	—
	24 Vdc	OPT	CF	CF	—	—	—
	48 Vdc	OPT	CF	CF	—	—	—
	120 Vac	STD	STD	STD	OPT ³	—	—
	240/208 Vac	OPT	OPT ³	OPT	STD	STD*	STD*
	480 Vac	OPT ³	OPT ³	OPT ³	OPT ³	OPT	OPT
<p>¹ Note: High ambient temperatures affect oil viscosity which may affect actuator rated output. Consult TM19-2 for complete temperature guidelines.</p> <p>² Refer to TM20-2 for additional information.</p> <p>³ Optional power voltage requires separate transformer.</p> <p>† These items are <u>not</u> supplied by KOSO AMERICA.</p> <p>* 3-phase power is required.</p> <p>‡ Minimum deadband for 600/1 200 models is 0.5%.</p>							
<p>REXA is continually improving the design of its products. As such, specifications are subject to change.</p>							

Check with factory about Accumulators and other options.

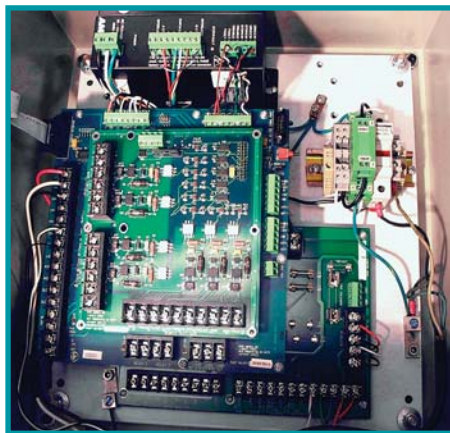

Features

CONTROL INTERFACE

The standard user interface is a five-button membrane key pad located on the outside of the control enclosure door. A two-line vacuum fluorescent emissive display is visible above the keypad.

Once the unit is wired, all calibration and operation functions can be performed without opening the enclosure. For installations where an external keypad is not possible, the display and a five-button control board may be mounted inside the enclosure.



POSITION TRANSMITTER

This standard feature allows for a two-wire 4-20 mA signal that is proportional to actuator position and selectable for direct or reverse action. The transmitter's output is optically isolated from the electronics and may be configured as an active or passive device. A passive position transmitter requires an external DC power source while an active device is powered from an internal 24 Vdc power supply.

	Passive	Active
Resolution	<0.1% of full stroke	
Maximum External Load	1000 ohms @ 36 Vdc	700 ohms @24 Vdc
Minimum Supply Voltage	$10 + (0.02 \times R_{LOAD})$ Vdc	24 Vdc (internal supply)
Maximum Supply Voltage	$36 + (0.004 \times R_{LOAD})$ Vdc	

RELAYS

Standard units are supplied with 4 AC/DC photo-MOS relays for output indications. Relays 1 and 2 are used as 'electronic limit switches' and may be set in the calibration mode. Relays 3 and 4 provide a warning (3) and/or alarm (4) to indicate possible problems with the equipment. (Load Voltage: 200 Vac/Vdc; Load Current: 1 amp)

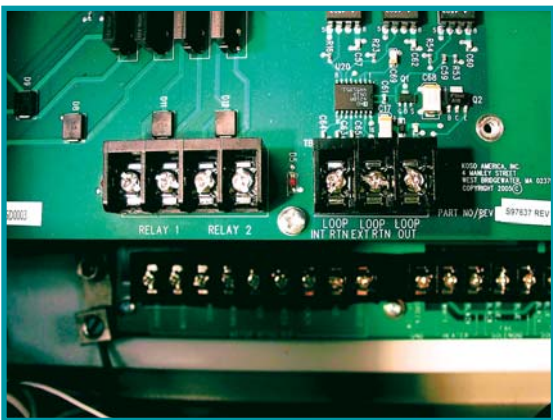

Relay #1 is used for low position indication. During calibration, it may be set from 0.1 to 99.9, but must be lower than Relay #2. The LED shows status of the relay; when the LED is on, the relay is energized.

Relay #2 is used for high position indication and may be set from 0.1 to 99.9, but must be higher than Relay #1. The LED shows status of the relay; when the LED is on, the relay is energized.

Alarm is used to indicate when the actuator is unable to follow the control signal as defined. The LED shows the status of the alarm relay; during an alarm event, the LED is turned off.

Warning is used when the actuator detects a problem, but is still able to operate as defined. The LED shows the status of the warning relay; during a warning condition, the LED is turned off.

FAIL-SAFE OPTIONS

The inherent response of a REXA actuator upon loss of power is to fail in place. For many services, this is the preferred “safe” position. However the hydraulic circuit can easily be adapted for an end of stroke fail-safe position. Two options exist to accomplish this mode.

Spring Fail positioning involves a spring and a solenoid to open the hydraulic circuit allowing the spring to drive the shaft to the desired position, either extended or retracted. Since the spring is mounted in series with the cylinder, a portion of the hydraulic force is used to compress the spring during stroking. Refer to Table 1 for end of travel forces when selecting a spring return unit.

Rotary Spring Selection

The chart below provides the **Spring Rate**, **Spring Initial** and **Spring Final** forces in pounds for each spring matched to its appropriate linear cylinder. Use the three steps below the table to select the proper spring for each application.

Table 1 Rotary Spring Selection Chart

Cylinder Torque (lb-in)	Spring Rate (lb/90° of rotation)	Spring Initial (lb)	Spring Final (lb)
2500	625	1000	1625
5000	1250	2000	3250
10000	2500	4000	6500
20000	5000	8000	13000
100000	12500	20000	32500

1. Using **Spring Initial**, determine the lowest cylinder/spring rate combo that will meet the fail-safe shut-off requirement and provide the required cylinder travel.
2. Subtract the **Spring Initial** from the **Cylinder Torque** to make sure there is sufficient force to initiate travel.
3. Subtract the **Spring Final** from the **Cylinder Torque** to make sure there is sufficient force to fully stroke the application.

Accumulator Fail positioning replaces the spring with a reservoir and piston-type accumulator placed parallel with the cylinder. This eliminates the need to “oversize” the cylinder to make up for the force required to compress the spring. While the power module is used to pressurize the accumulator, it is isolated from the main hydraulic circuit during normal operation. Table 2 provides estimated times for failure based on cylinder size and stroke.

Table 2

Model	Estimated Fail Time* (seconds)
R2500	.30
R5000	.40
R10000	.50
R20000	.75
R100000	3.0

*For additional information refer to PM21-2.

MANUAL OVERRIDE OPTIONS

When electric power is unavailable, REXA actuators can be operated with one of two manual operators.



A **Declutchable Handwheel/Drill Drive** may be mounted to the back end of the motor. Once engaged, it can be used to turn the motor shaft and hence the pump in either direction. Removing the handwheel from this mechanism reveals a hex drive which allows for the connection of a corded or cordless drill.

A **Manual Hydraulic Pump** may be mounted on the actuator. This unit bypasses the pump and FMV, drawing oil from one side of the cylinder and displacing it to the other. This unit offers significantly faster operating speeds than the handwheel.

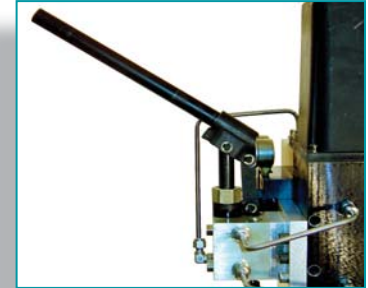

Manual Override Device	Handwheel on Power Module			Manual Hand Pump
	B	C	D	
Flow Rate	0.01 in ³ /rev	0.03 in ³ /rev	0.054 in ³ /rev	0.50 in ³ /pump
Revolutions or Pumps per 1000 lbf per 90° of rotation	200	65	36	4

DEVICE COMMUNICATIONS

The standard control signal for the X2 Series is an analog 4-20 mA signal. Optional control boards are used to provide a choice of control signals; including Pulse, HART Enabled and FOUNDATION fieldbus™ communications.

PULSE OPERATING SYSTEMS

Originally developed for gearmotor actuators, these systems provide a pulsed low-power signal to define the required position. The system can be adjusted for a variety of pulse durations (time of the pulse) and increments (percent of resulting stroke). For additional information, refer to PM 16-2.

HART COMMUNICATION PROTOCOL

The HART protocol board uses a frequency shifting key (FSK) modem to impose a digital signal on top of the 4-20 mA analog loop. This allows for continuous control via the analog signal as well as bidirectional digital communications. The HART Protocol Revision 5.0 implemented in the X2 utilizes the Universal Commands as well as a limited number of Common Practice and Device Specific Commands. This implementation eliminates the need for a specific Device Driver (DD). When a field instrument is polled, it will report Universal and Common Practice Commands. These commands include Device Status

and the Dynamic Variables. The Dynamic Variables are Position (the Primary Variable) and Cylinder Pressure Differential (optional and requires additional equipment).

FOUNDATION Fieldbus™ H1 Integration

An option I/O board converts X2 control parameters for FOUNDATION fieldbus communication. The Resource Block provides device identification while Analog Blocks communicate information such as set point, position, and actuator cylinder differential pressure (optional). The device status including operating mode and any error conditions can also be communicated. Partial Stroke Testing (PST) functionality is available through a data collection function. Up to 200 samples of the set point, position and differential pressure (if so equipped), can be collected and stored. The collection rate can be set from 1 to 20 samples per second. Collection can be initiated “manually” via the network or automatically via a definable set point differential.



CONTROL PARAMETERS

During calibration of the unit, certain parameters that set the operating and control range are required. These are entered through the Calibrate menu in the Setup mode. Additional menus offer several other adjustments that will allow the user to fine tune the operation of the X2 to their specific application. Some of the options are listed below. For additional information on any of these parameters refer to the *Installation and Operation Manual*.

SPEED, ACCELERATION AND GAIN

Multiple settings are available that allow the unit to be fine tuned for a specific application. The units gain can be changed to adjust how aggressively it responds to a change in signal. Multiple rates of acceleration (ramping of speed) and speed can be set along with parameters that define when to switch between the options. Different operating speeds can even be set for Manual and Auto operation modes.

DEADBAND

Deadband is the maximum allowable deviation on a percentage basis, between the defined signal range and defined travel range. This can be set anywhere from 0.05% to 5.00%. A lower setting generally improves accuracy while a higher setting reduces motor duty cycle, power consumption and seal wear, extending actuator life cycle.

BUMPLESS TRANSFER

This setting allows the user to define the total time the actuator takes to travel to the current target when switched from Local or Setup to Auto. This function can be helpful in preventing upsets in systems that can not handle rapid flow disturbances. With a range from 10 to 90 (seconds), the default setting is Off.

MINIMUM MODULATION

This parameter sets the upper limit of an optional no-modulating band at the low (closed) end of travel. Many

severe service valves reduce fluid energy through staged pressure reductions. These designs often include a minimum control Cv, below which the pressure reduction occurs between the seat and plug rather than a resistive element. Operation in this range usually results in costly trim damage and plant down time. Min-Mod allows the valve to close or remain closed for any signal below the corresponding minimum Cv and operate normally for signals above the minimum Cv, extending valve life. With a range from 0.1 to 99.9 (percent of calibrated stroke), the default setting is Off.

FLOW CHARACTERIZATION

The Xpac is designed to have an inherent linear relationship between Control Signal and stroke (i.e.: 10% CS = 10% stroke). The ability to modify this characteristic can assist in loop tuning. Changing the Xpac's characteristic can have a profound effect on the behavior of the control loop and should only be undertaken with a thorough understanding of the effect. The stroke position can be modified at 10% control signal intervals. The only restriction is that each stroke position must be between and at least 2.5% from the adjacent positions. The default setting is Off.

REMOTE MANUAL CONTROL

The actuator may be equipped to connect to a remotely located manual station. The basic station includes one Remote/Auto: two-position maintained switch and one Open/Off/Close: three-position maintained switch. The two-position switch is used to alternate between Auto and Auto-Rman (remote manual) modes. In the Auto-Rman mode, turning the three-position switch to Open or Close will move the actuator in the open or close direction. Returning to center (Off) will stop the actuator at the current position. As an additional option, a seven segment LED digital display board may be connected to the standard position transmitter to display actuator position at the remote manual station. ■

How To Order

The model number provides a physical description of the mechanical portion of the actuator. The output torque, power modules and failure mode are described in this simple system. The rotation rate specifies the maximum speed of operation for a particular actuator and power module combination. Contact your local representative for complete product definitions, cost and availability.

Model Number

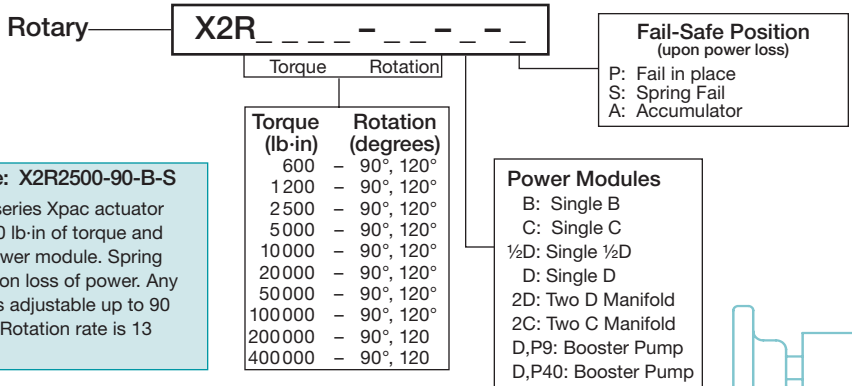

Example: X2R2500-90-B-S
A rotary series Xpac actuator with 2500 lb-in of torque and B size power module. Spring failure upon loss of power. Any rotation is adjustable up to 90 degrees. Rotation rate is 13 seconds.

REXA is continually improving the design of its products. As such, specifications are subject to change.

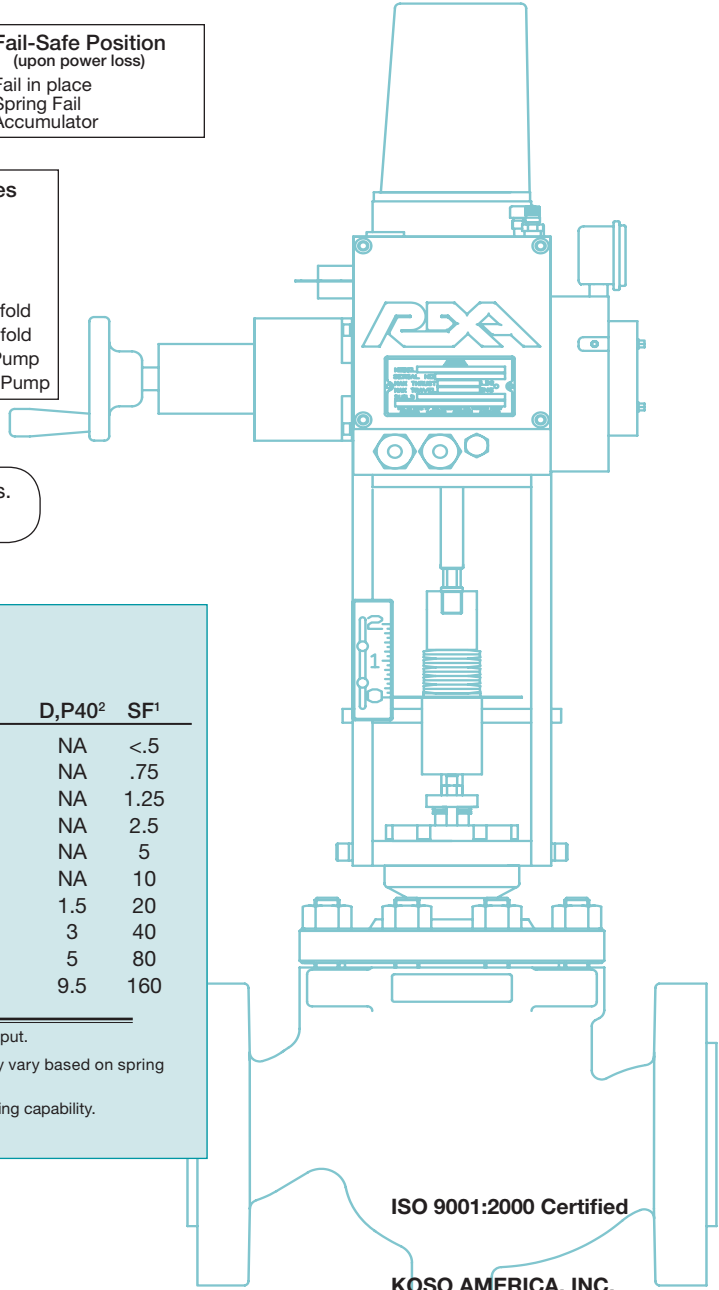

Rotation Rate (seconds per 90° rotation)

Torque lb-in (N·m)	Power Module							
	B	C	½D/2C	D	2D	D,P9 ²	D,P40 ²	SF ¹
600 (68 N·m)	3.25	1.1	NA	NA	NA	NA	NA	<.5
1200 (136 N·m)	6.5	2.2	1.1	NA	NA	NA	NA	.75
2500 (282 N·m)	13	4.5	2.25	1.1	.55	NA	NA	1.25
5000 (565 N·m)	26	9	4.5	2.25	1.1	NA	NA	2.5
10000 (1130 N·m)	50	17	8.5	4	2	1	NA	5
20000 (2260 N·m)	100	34	17	8	4	2	NA	10
50000 (5650 N·m)	NA	85	43	22	11	4.5	1.5	20
100000 (11300 N·m)	NA	NA	85	43	22	8.5	3	40
200000 (22597 N·m)	NA	NA	NA	85	43	17	5	80
400000 (45194 N·m)	NA	NA	NA	170	85	34	9.5	160

In most installations, these speeds may be reduced by a factor of four without affecting the rated output.

¹SE—Spring Failure. Estimated time is for the standard solenoid and spring. The actual times may vary based on spring force and temperature. Faster times are available

²D,P9 and D,P40. Booster pumps provide high speed operation, while maintaining our fine positioning capability. Please refer to PM23 - Booster Pumps

ISO 9001:2000 Certified

KOSO AMERICA, INC.
4 Manley Street
W. Bridgewater, MA 02379

Telephone: 508.584.1199
Fax: 508.584.2525
www.rexa.com